



**STÄRKER**  
**E3**



**CATÁLOGO DE PARTES**

**¡ENERGIZA TU VIDA**

**#LANUEVAENERGÍA**

---

## PREFACIO

---

Es nuestro placer presentarles a ustedes el Catálogo de Partes.

Este Catálogo ha sido especialmente diseñado para ayudarle en la selección de las partes correctas con el fin de mantener el vehículo en las mejores condiciones.

Los repuestos originales están sujetos a un exigente estándar de control de calidad, por lo tanto es necesario que usted sólo use repuestos originales.

En nuestro constante esfuerzo para mejorar la eficiencia y desempeño de su vehículo, las especificaciones, diagramas y número de partes pueden cambiar sin previo aviso. Consecuentemente las descripciones de los repuestos en este Catálogo pueden no ser las finales y definitivas.

Las alteraciones y modificaciones que ocurren en la impresión de este Catálogo, serán informadas a nuestra red, a través de circulares de Servicio o en nuestra página web: [www.auteco.com.co](http://www.auteco.com.co) accediendo al link repuestos. Es requisito que usted actualice su Catálogo y haga las correcciones necesarias, una vez reciba dichas circulares. Lo anterior le asegurará un rápido y adecuado despacho de sus partes, pues las órdenes están siendo diligenciadas con las referencias más actualizadas.

En caso de necesitar asistencia técnica, comunicarse con el Distribuidor Autorizado o llamar al Departamento de Servicios Auteco.



# ÍNDICE

## DESCRIPCIÓN

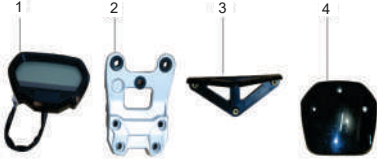
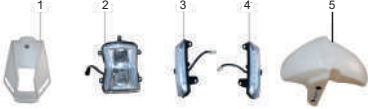
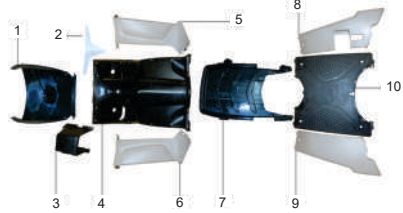
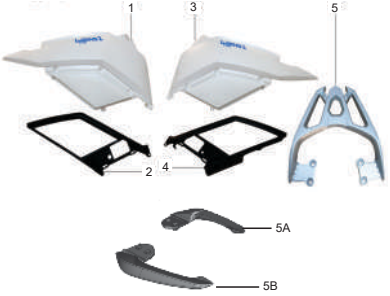

## PÁG. N°

MANUBRIO - ESPEJOS .....	1
VELOCÍMETRO .....	2
FAROLA - GUARDABARRO DELANTERO.....	3
CUBIERTAS .....	4
CUBIERTA SILLÍN - AGARRADERA PASAJERO .....	5
CAJA GUANTERA - CAJA BATERÍA .....	6
GUARDABARRO TRASERO - STOP .....	7
SUSPENSIÓN DELANTERA - ESPIGA CENTRAL .....	8
BOMBA FRENO DELANTERO .....	9
RUEDA DELANTERA .....	10
RUEDA TRASERA .....	11
BRAZO OSCILANTE - AMORTIGUADOR TRASERO .....	12
CHASIS .....	13
EQUIPO ELÉCTRICO .....	14
CALCOMANÍAS .....	15

## ÍNDICE DE GRÁFICOS

		
<p><b>FIGURA N° 1: MANUBRIO - ESPEJOS</b></p>	<p><b>FIGURA N° 2: VELOCÍMETRO</b></p>	<p><b>FIGURA N° 3: FAROLA - GUARDABARRO DELANTERO</b></p>
		
<p><b>FIGURA N° 4: CUBIERTAS</b></p>	<p><b>FIGURA N° 5: CUBIERTA SILLÍN - AGARRADERA PASAJERO</b></p>	<p><b>FIGURA N° 6: CAJA GUANTERA - CAJA BATERÍA</b></p>
<p style="text-align: right;">PAG 1</p>	<p style="text-align: right;">PAG 2</p>	<p style="text-align: right;">PAG 3</p>
<p style="text-align: right;">PAG 4</p>	<p style="text-align: right;">PAG 5</p>	<p style="text-align: right;">PAG 6</p>

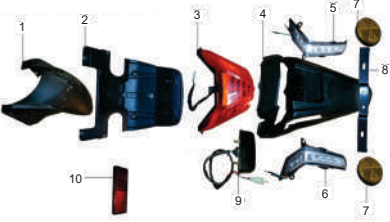
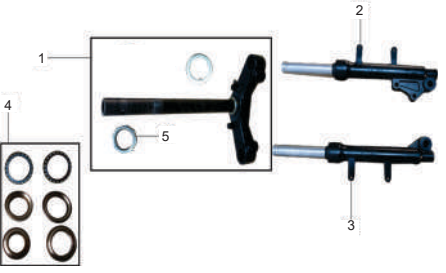
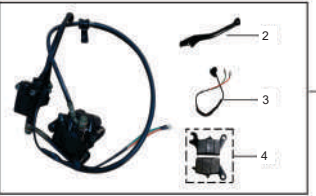
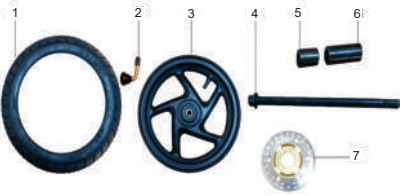
## ÍNDICE DE GRÁFICOS

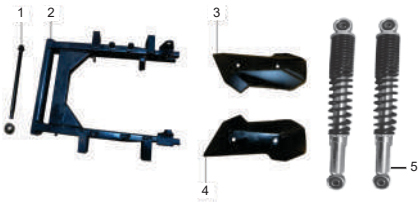
					
<p><b>FIGURA N° 7: GUARDABARRO TRASERO - STOP</b></p>	<p><b>PAG 7</b></p>	<p><b>FIGURA N° 8: SUSPENSIÓN DELANTERA - ESIPIGA CENTRAL</b></p>	<p><b>PAG 8</b></p>	<p><b>FIGURA N° 9: BOMBA FRENO DELANTERO</b></p>	<p><b>PAG 9</b></p>
					
<p><b>FIGURA N° 10: RUEDA DELANTERA</b></p>	<p><b>PAG 10</b></p>	<p><b>FIGURA N° 11: RUEDA TRASERA</b></p>	<p><b>PAG 11</b></p>	<p><b>FIGURA N° 12: BRAZO OSCILANTE - AMORTIGUADOR TRASERO</b></p>	<p><b>PAG 12</b></p>

## ÍNDICE DE GRÁFICOS

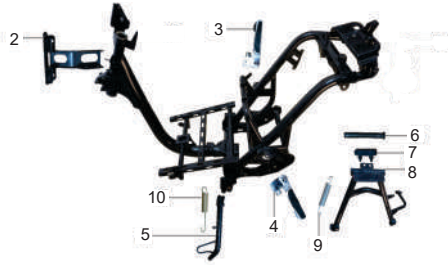

**FIGURA N° 13: CHASIS**

**PAG 13**

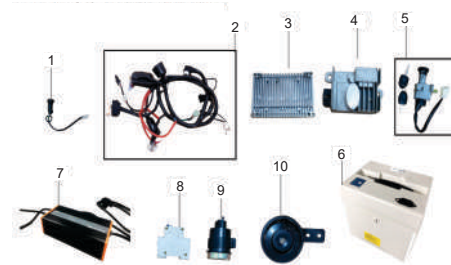

**FIGURA N° 14: EQUIPO ELÉCTRICO**

**PAG 14**

**FIGURA N° 15: CALCOMANÍAS**

**PAG 15**

FIGURA N° 1: MANUBRIO - ESPEJOS

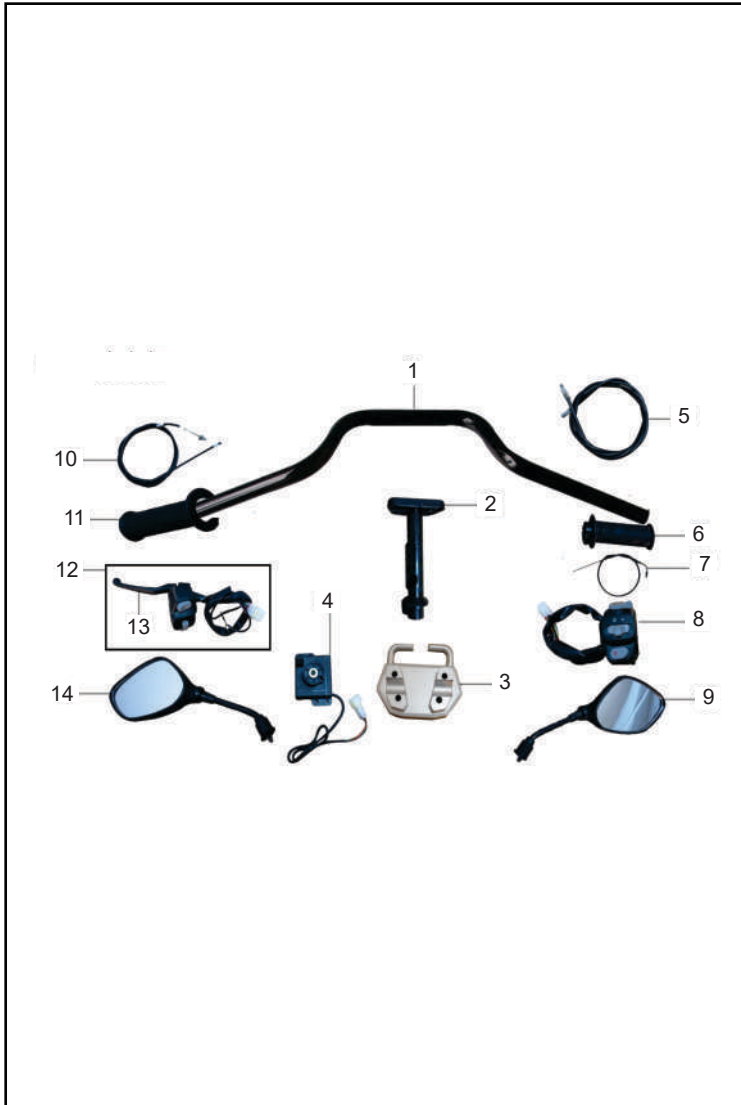

FIG. No.	PORTE No.	DESCRIPCIÓN	CANT. VEH.	OBSERVACIÓN
1	DTX47111A0B01	Manubrio	1	
2	DTX51810A0B01	Tubo Dirección	1	
3	DTX51311A0W01	Soporte Inferior Manubrio	1	
4	DTX47340A0A00	Acelerador	1	
5	DTX46530A0A00	Cable Seguro Sillín	1	
6	DTX47311A0A00	Manillar Derecho	1	
7	DTX46300A0A00	Cable Acelerador	1	
8	DTX35100A0A00	Comando Derecho	1	
9	DTX57100A1B01	Espejo Derecho	1	
10	DTX46410A0A00	Cable Freno Trasero	1	
11	DTX47411A0A00	Manillar Izquierdo	1	
12	DTX35200A0A00	Soporte y Leva Freno Trasero	1	
13	DTX47651A0B03	Leva Freno Trasero	1	
14	DTX57200A1B01	Espejo Izquierdo	1	



FIGURA N° 2: VELOCÍMETRO



FIG. No.	PARTE No.	DESCRIPCIÓN	CANT. VEH.	OBSERVACIÓN
1	DTX37000A0A00	Velocímetro	1	
2	DTX47151A0W01	Soporte Velocímetro	1	
3	DTX37911A0B01	Soporte Visor	1	
4	DTX43131A0B02	Visor	1	

**FIGURA N° 3: FAROLA - GUARDABARRO DELANTERO**



FIG. No.	PARTE No.	DESCRIPCIÓN	CANT. VEH.	OBSERVACIÓN
1	DTX43251A0W20	Cubierta Frontal	1	Sin Pintar
	DTX43251A0W17		1	Blanco
	DTX43251A0C54		1	Azul
	DTX43251A0B02		1	Negro
2	DTX33100A0A00	Farola	1	
3	DTX33550A0A00	Direccional Delantera Derecha	1	
4	DTX33510A0A00	Direccional Delantera Derecha	1	
5	DTX53111A0W20	Guardabarro Delantero	1	

**FIGURA N° 4: CUBIERTAS**

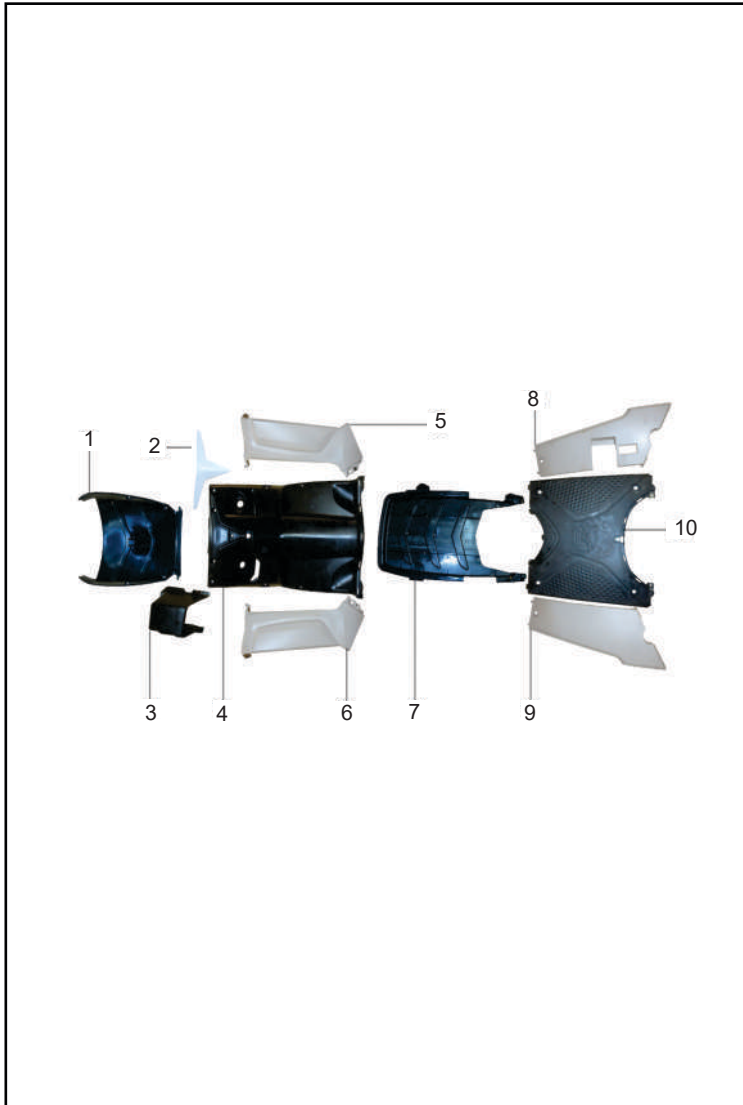

FIG. No.	PARTE No.	DESCRIPCIÓN	CANT. VEH.	OBSERVACIÓN
1	DTX43334A0A00	Cubierta Frontal Inferior Interna	1	
2	DTX43659A0M01	Complemento Carenaje Frontal Interno	1	
3	DTX49813A0A00	Guantera Delantera	1	
4	DTX43651A0A00	Carenaje Frontal Interno	1	
5	DTX43211A0W20	Cubierta Frontal Inferior Derecha	1	
6	DTX43221A0W20	Cubierta Frontal Inferior Izquierda	1	
7	DTX43333A0A00	Piso Inferior	1	
8	DTX43361A0W20	Cubierta Lateral Inferior Derecha	1	
9	DTX43461A0W20	Cubierta Lateral Inferior Izquierda	1	
10	DTX42381A0A00	Piso Superior	1	



FIGURA N° 6: CAJA GUANTERA - CAJA BATERÍA



FIG. No.	PARTE No.	DESCRIPCIÓN	CANT. VEH.	OBSERVACIÓN
1	DTX43663A0A00	Cubierta Central Interna	1	
2	DTX43677A0A00	Caja Batería	1	
3	DTX43661A0A00	Caja Guanterera	1	
4	DTX43662A0A00	Tapa Interna Guanterera	1	
5	DTX43669A0A00	Complemento Tapa Interna Guanterera	1	
6	DTX43676A0N01	Resorte Complemento Tapa Interna Guanterera	1	
7	DTX44100A1A00	Sillín	1	
8	DTX31854A0N01	Resorte Tapa Interna Guanterera	4	
9	DTX31851A0A00	Caucho Tapa Interna Guanterera	4	
10	DTX44926A0A00	Antivibrante Batería	4	
11	DTX43654A0A00	Complemento Caja Guanterera	1	

**FIGURA N° 7: GUARDABARRO TRASERO - STOP**

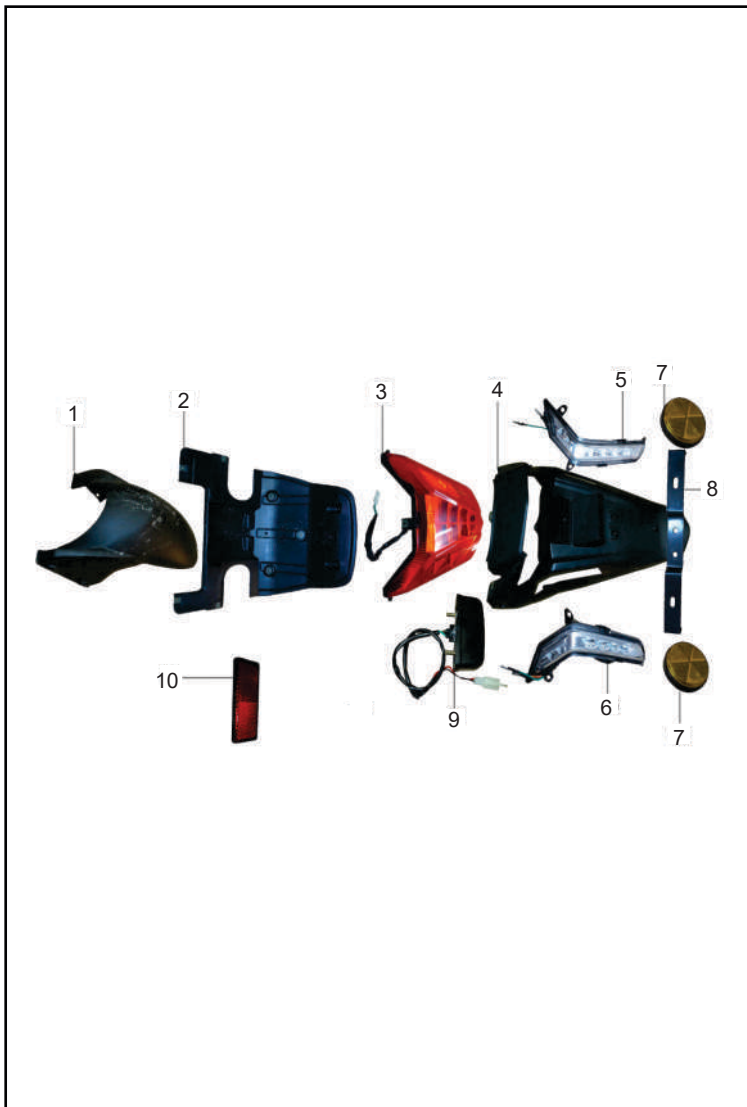

FIG. No.	PORTE No.	DESCRIPCIÓN	CANT. VEH.	OBSERVACIÓN
1	DTX63111A0A00	Guardabarro Trasero Interno	1	
2	DTX63131A0A00	Cubierta Trasera Interna	1	
3	DTX33700A0A00	Stop	1	
4	DTX63151A0A00	Guardabarro Trasero	1	
5	DTX33610A0A00	Direccional Trasera Derecha	1	
6	DTX33650A0A00	Direccional Trasera Izquierda	1	
7	ZJA33820A0A00	Reflectivo Lateral	2	
8	QJG63710A0B01	Soporte Porta Placa	1	
9	QJZ33760A0A00	Luz Placa	1	
10	XGA33820A1A00	Reflectivo Trasero	1	



**FIGURA N° 9: BOMBA FRENO DELANTERO**



FIG. No.	PARTE No.	DESCRIPCIÓN	CANT. VEH.	OBSERVACIÓN
1	DTX56010A0B01	Conjunto Freno Delantero Completo	1	
2	DTX47511A0B03	Leva Freno Delantero	1	
3	DTX35310A0A00	Sensor Freno	1	
4	DTX56520A0A00	Pastas Freno Delantero	1	



**FIGURA N° 10: RUEDA DELANTERA**



FIG. No.	PARTE No.	DESCRIPCIÓN	CANT. VEH.	OBSERVACIÓN
1	DTX54700A0A00	Llanta Delantera 3.00x10	1	(Opcional)
	80/90-10-MB38-TL	Llanta delantera 80/90-10-MB38-TL	1	IRC (Opcional)
2	Q981BDQ07C	Válvula Tubeless	1	
3	DTX54100A0B01	Rin Delantero	1	
4	NIX61951A1N01	Eje Rueda Delantera	1	
5	DTX54913A0N01	Buje Izquierdo Rueda Delantera	1	
6	DTX54912A0N01	Buje Derecho Rueda Delantera	1	
7	DTX56311A0B01	Disco Freno Delantero	1	



**FIGURA N° 12: BRAZO OSCILANTE - AMORTIGUADOR TRASERO**



<b>FIG. No.</b>	<b>PARTE No.</b>	<b>DESCRIPCIÓN</b>	<b>CANT. VEH.</b>	<b>OBSERVACIÓN</b>
1	DIX61951A0N04	Pasador Brazo Oscilante	1	
2	DTX61101A0B01	Brazo Oscilante	1	
3	DTX63471A0A00	Cubierta Motor Derecha	1	
4	DTX63472A0A00	Cubierta Motor Izquierda	1	
5	DTX62100A0B01	Amortiguador Trasero	2	

**FIGURA N° 13: CHASIS**

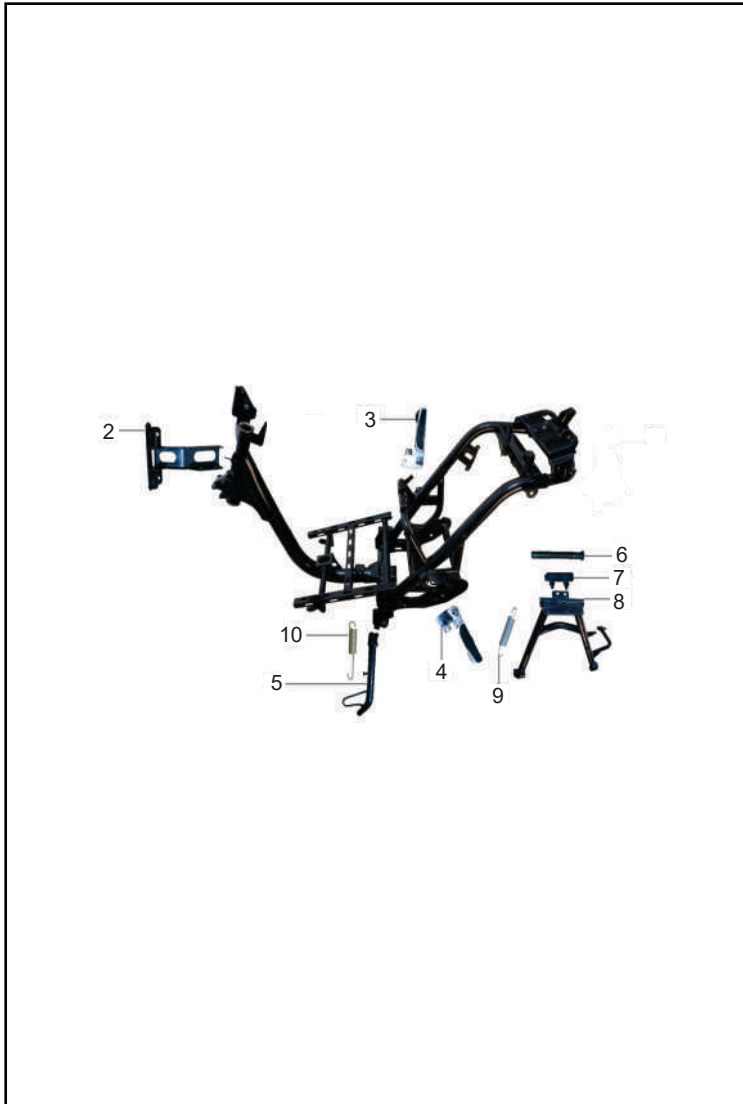

FIG. No.	PARTE No.	DESCRIPCIÓN	CANT. VEH.	OBSERVACIÓN
1	DTX35360A0A00	Swiche Gato Lateral	1	No Ilustrado
2	DTX43830A0B01	Soporte Cubierta Frontal Inferior	1	
3	DTX42500A0W01	Reposapie Pasajero Derecho	1	
4	DTX42600A0W01	Reposapie Pasajero Izquierdo	1	
5	DTX42210A0B01	Gato Lateral	1	
6	YHL42911A0N04	Pasador Gato Central	1	
7	WIA42191A0A00	Antivibrante Gato Central	1	
8	DTX42100A0B01	Gato Central	1	
9	DTX42913A0N01	Resorte Gato Central	1	
10	DTX42922A0N01	Resorte Gato Lateral	1	

FIGURA N° 14: EQUIPO ELÉCTRICO

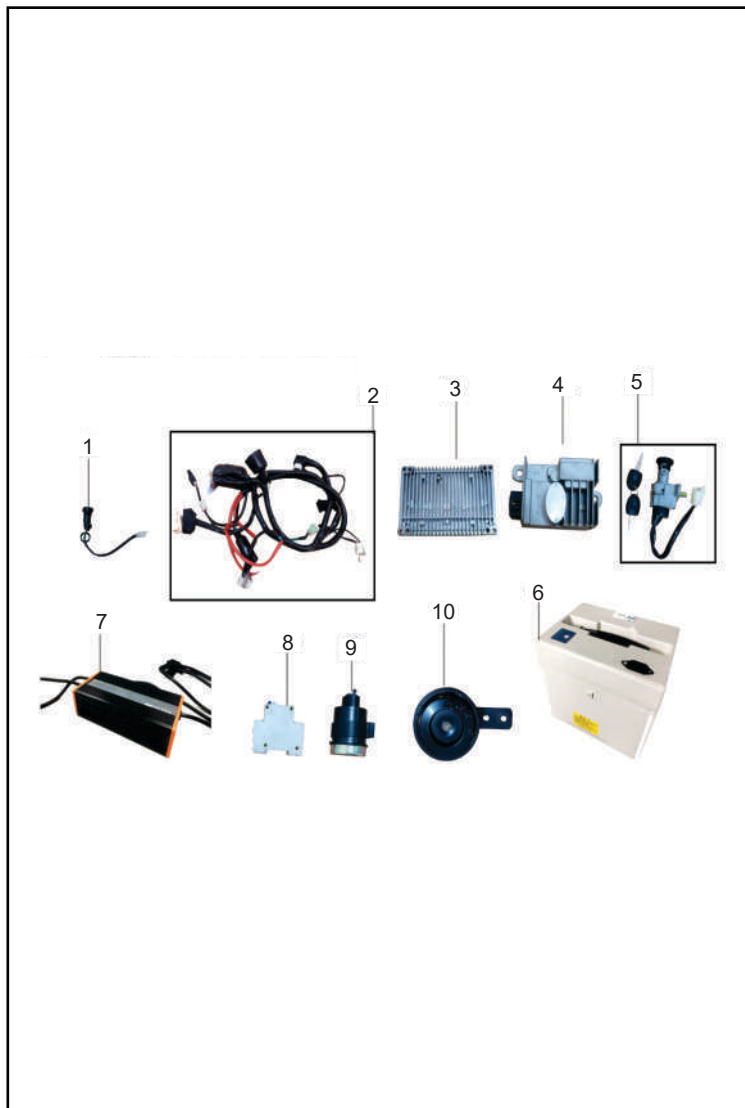

FIG. No.	PARTE No.	DESCRIPCIÓN	CANT. VEH.	OBSERVACIÓN
1	YHG36150A0A00	Puerto USB	1	
2	DTX32100A0A00	Instalación Electrica	1	
3	DTX38640A0A00	Controlador	1	
4	DTX36290A0A00	Convertidor	1	
5	DTX35400A0A00	Swiche Encendido Completo	1	
6	DTX31500A0A00	Batería 60V-24AH	1	
7	QLL36150A0A00	Cargador Bateria	1	
8	DTX35570A0A00	Breaker	1	
9	DTX38210A0A00	Relay Direccionales	1	
10	YGA38100A0B01	Pito	1	

FIGURA N° 15: CALCOMANÍAS



FIG. No.	PARTE No.	DESCRIPCIÓN	CANT. VEH.	OBSERVACIÓN
1	LDTX.B2013.C54	Kit Calcomanías	1	Moto Azul
	LDTX.B2012.W17		1	Moto Blanca
	LDTX.B2069.B02		1	Moto Negra

## ÍNDICE DE REFERENCIAS

PARTE No.	FIG. No.	PAG. No.
80/90-10-MB38-TL	1	10
90/90-10-MB62-TL	1	11
90/90-10P239-TL-Q	1	11
DIX61951A0N04	1	12
DTX31500A0A00	6	14
DTX31851A0A00	9	6
DTX31854A0N01	8	6
DTX32100A0A00	2	14
DTX33100A0A00	2	3
DTX33510A0A00	4	3
DTX33550A0A00	3	3
DTX33610A0A00	5	7
DTX33650A0A00	6	7
DTX33700A0A00	3	7
DTX35100A0A00	8	1
DTX35200A0A00	12	1
DTX35310A0A00	3	9
DTX35360A0A00	1	13
DTX35400A0A00	5	14
DTX35570A0A00	8	14
DTX36290A0A00	4	14
DTX37000A0A00	1	2
DTX37911A0B01	3	2
DTX38210A0A00	9	14

PARTE No.	FIG. No.	PAG. No.
DTX38630A0A00	2	11
DTX38640A0A00	3	14
DTX42100A0B01	8	13
DTX42210A0B01	5	13
DTX42381A0A00	10	4
DTX42500A0W01	3	13
DTX42523A0A00	4	5
DTX42600A0W01	4	13
DTX42623A0A00	2	5
DTX42913A0N01	9	13
DTX42922A0N01	10	13
DTX43131A0B02	4	2
DTX43211A0W20	5	4
DTX43221A0W20	6	4
DTX43251A0B02	1	3
DTX43251A0C54	1	3
DTX43251A0W17	1	3
DTX43251A0W20	1	3
DTX43333A0A00	7	4
DTX43334A0A00	1	4
DTX43361A0W20	8	4
DTX43461A0W20	9	4
DTX43651A0A00	4	4
DTX43654A0A00	11	6

PARTE No.	FIG. No.	PAG. No.
DTX43659A0M01	2	4
DTX43661A0A00	3	6
DTX43662A0A00	4	6
DTX43663A0A00	1	6
DTX43669A0A00	5	6
DTX43676A0N01	6	6
DTX43677A0A00	2	6
DTX43711A0W20	3	5
DTX43721A0W20	1	5
DTX43830A0B01	2	13
DTX44100A1A00	7	6
DTX44926A0A00	10	6
DTX45511A0W01	5	5
DTX45511A1W01	5A	5
DTX45531A0W01	5B	5
DTX46300A0A00	7	1
DTX46410A0A00	10	1
DTX46530A0A00	5	1
DTX47111A0B01	1	1
DTX47151A0W01	2	2
DTX47311A0A00	6	1
DTX47340A0A00	4	1
DTX47411A0A00	11	1
DTX47511A0B03	2	9

PARTE No.	FIG. No.	PAG. No.
DTX47651A0B03	13	1
DTX49813A0A00	3	4
DTX51200A0B01	1	8
DTX51311A0W01	3	1
DTX51810A0B01	2	1
DTX51910A0A00	4	8
DTX52400A0B01	3	8
DTX52500A0B01	2	8
DTX53111A0W20	5	3
DTX54100A0B01	3	10
DTX54700A0A00	1	10
DTX54912A0N01	6	10
DTX54913A0N01	5	10
DTX56010A0B01	1	9
DTX56311A0B01	7	10
DTX56520A0A00	4	9
DTX57100A1B01	9	1
DTX57200A1B01	14	1
DTX61101A0B01	2	12
DTX62100A0B01	5	12
DTX63111A0A00	1	7
DTX63131A0A00	2	7
DTX63151A0A00	4	7
DTX63471A0A00	3	12

PARTE No.	FIG. No.	PAG. No.
DTX63472A0A00	4	12
DTX64700A0A00	1	11
DTX65100A0B03	3	11
DTX65110A0A00	5	11
DTX93241A0N03	5	8
LDTX.B2012.W17	1	15
LDTX.B2013.C54	1	15
LDTX.B2069.B02	1	15
NIX61951A1N01	4	10
Q981BDQ07C	2	10
Q981BDQ07C	4	11
QJG63710A0B01	8	7
QJZ33760A0A00	9	7
QLL36150A0A00	7	14
WIA42191A0A00	7	13
XGA33820A1A00	10	7
YGA38100A0B01	10	14
YHG36150A0A00	1	14
YHL42911A0N04	6	13
ZJA33820A0A00	7	7

## FICHA TÉCNICA E3

CARACTERÍSTICAS	UNIDAD
Desempeño	55 / 65 @ 45
Tipo Motor :	Motor HUB DC Sin Escobillas
Potencia Motor (Watts Nominal)	1500W
Potencia Motor (Watts Máximo)	2000W
Potencia Máxima Motor (HP)	2.68 HP
Número Modos de Manejo	3
Velocidad Máxima	55 KM/H
Autonomía	65 KM
Costo de Cargar 100%	\$ 749
Torque Máximo	80 NM
Peso Bruto (KG)	85 KG
Suspensión Delantera	Telescópica
Suspensión Trasera	Doble Amortiguador
Freno Delantero	Disco
Freno Trasero	Campana
Llanta Delantera	3.00-10 Sellomatic
Llanta Trasera	100/80-10 Sellomatic
Rines	Aspas
Batería	60V / 24 AH
Capacidad Batería (KWH)	1.4 KWH
Vida Útil Batería (Ciclos de Carga Completa)	1000
Tiempo de Carga	6 - 8 H
Tablero de Información	Digital
Tipo de Batería	Litio Ion
Batería Removible(Si/No)	Si
Freno Regenerativo	Si
Alarma	No
Tipo de Tomacorriente	110 V / 60 Hz
Garantía Vehículo	12 meses o 25.000 KM
Garantía Batería	12 meses o 25.000 KM
Largo x Ancho x Alto	1680 mm x 750 mm x 1090
Altura Silla al Piso (MM)	750
Carga Máxima (KG)	140 KG



# STÄRKER E3







**STÄRKER**  
Vehículos Eléctricos





**STÄRKER**  
Vehículos Eléctricos

[www.auteco.com.co](http://www.auteco.com.co)

Línea gratuita nacional: 018000 520090

